



THE TEKTRONIX COOKBOOK OF STANDARD AUDIO TESTS

using the 5L4N low frequency spectrum analyzer



NAVIGOR 30 WATT AUDIO AMPLIFIER SPECIFICATIONS

FREQUENCY RESPONSE	INTERMODULATION DISTORTION
40-20,000 cycles ± 1.5 db at 30 watts	any three 20% 3 peak waves to
10-20,000 cycles ± 1.5 db at 60 watts	below 60 watts
10-10,000 cycles ± 1.5 db at 15 watts	

PHASE SHIFT
10° at 20 cycles, 90° at 20,000 cycles

HARMONIC DISTORTION
less than .01% at 30 watts output
20-20,000 cycles

Copyright © 1975, Tektronix, Inc. All rights reserved. Printed in U.S.A. Foreign and U.S.A. Products of Tektronix, Inc. are covered by Foreign and U.S.A. Patents and/or Patents Pending. Information in this publication supersedes all previously published material. Specification and price change privileges reserved. TEKTRONIX, SCOPE-MOBILE, TELEQUIPMENT, and  are registered trademarks of Tektronix, Inc., P. O. Box 500, Beaverton, Oregon 97077, Phone: (Area Code 503) 644-0161, TWX: 910-467-8708, Cable: TEKTRONIX. Overseas Distributors in over 40 Countries.

STANDARD AUDIO TESTS

BY

CLIFFORD SCHROCK

ACKNOWLEDGEMENTS

The author would like to thank Linley Gumm and Gordon Long for their excellent technical assistance in the preparation of this paper. In addition, I would like to thank Joyce Lekas for her editorial assistance and Jeanne Galick for the illustrations and layout.

CONTENTS

PRELIMINARY INFORMATION

Test Setups _____	page 2
Input- Output Load Matching _____	page 3

TESTS

Power Output _____	page 4
Frequency Response _____	page 5
Harmonic Distortion _____	page 7
Intermodulation Distortion _____	page 9
Distortion vs Output _____	page 11
Power Bandwidth _____	page 11
Damping Factor _____	page 12
Signal to Noise Ratio _____	page 12
Square Wave Response _____	page 15
Crosstalk _____	page 16
Sensitivity _____	page 16
Transient Intermodulation Distortion _____	page 17
SERVICING HINTS _____	page 19

PRELIMINARY INFORMATION

Maintaining a modern High-Fidelity-Stereo system today requires much more than a "trained ear." The high specifications of receivers and amplifiers can only be maintained by performing some of the standard measurements such as:

1. Power output
2. Harmonic distortion
3. Intermodulation distortion
4. Frequency response
5. Signal-to-Noise measurements

Unfortunately, because of the available test equipment and lengthy procedures that are required to "spec" a new or repaired amplifier, it usually doesn't get done.

This pamphlet describes an alternative test device and procedures that permit rapid, easy to understand, "spec'ing" and troubleshooting. The device, a Low Frequency Spectrum Analyzer, is now available, at a moderate price, to the Audio Industry. In addition, besides the standard measurements, the spectrum analyzer may be used effectively for expanding the standard tests or for special measurements such as the CCIF distortion or Bell Telephone multitone audio tests.

These descriptions are presented so that they can be followed by anyone with a technical background. Procedures apply to all the standard tests typically performed on high fidelity equipment.

Test Setups

The only major test equipment that is really required to "spec" an amplifier with our new techniques are; the Tektronix 5L4N Low Frequency Spectrum Analyzer plug-in unit with a 5100-Series mainframe, and an audio oscillator, such as the Tektronix SG502 (Figures 1 and 2).

Some complementary test equipment that may be useful would be a vertical amplifier plug-in, such as the 5A15, to be inserted beside the 5L4N so the mainframe can be used as a standard time domain oscilloscope; a digital multimeter, such as the DM502, that reads out in dB's, for troubleshooting; and a frequency counter, such as the DC-504. An attenuator with a 0 to 60 or 80 dB range can be a handy test device for audio measurements. Two kinds to consider are the variable (potentiometer) type or a step attenuator. You may want to build attenuators. Construction details are given in Figure 3 and 4 for both the step and variable types.

To ensure accurate measurements, certain precautions must be observed. AC power or high level RF fields from local radio or TV transmitters can interfere with the low level measurements encountered in Hi-Fi systems. The typical test setup, Figure 5, should be well shielded. Use a copper sheet for the test bench top and ground all equipment through short pieces of copper braid to the copper sheet. The use of an AC line filter on the bench plugs is also recommended. Try reversing the AC plugs on equipment to obtain minimum hum.



Figure 1 5L4N Low Frequency Analyzer and Mainframe with 5A15



Figure 2 SG502, TM503, DM502, DC-504 Audio Test Package

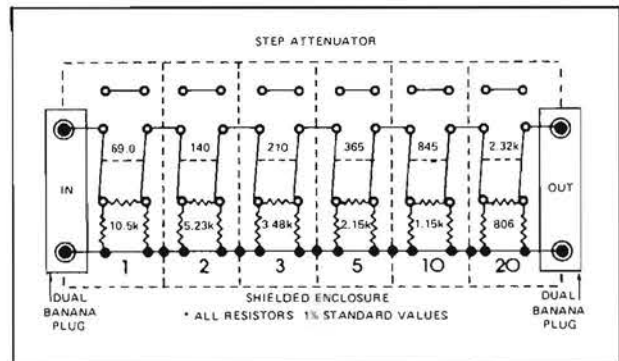

Figure 3 Construction Details for a Step Attenuator

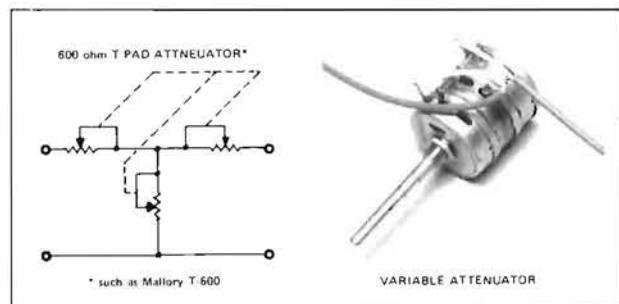

Figure 4 A Variable Attenuator

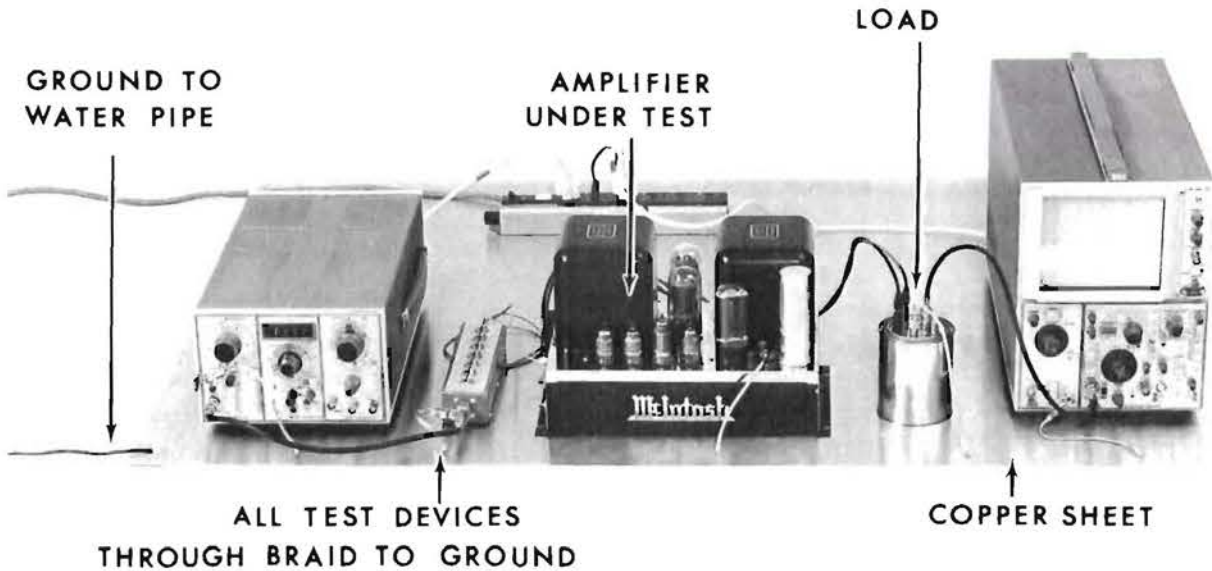

Figure 5 Typical Test Setup with Good Shielding

As a final note, wherever possible perform measurements with input signals about 30 dB above the measured reference sensitivity, using the volume control on the preamplifier to obtain reference power output.

CAUTION

Some consumer high fidelity equipment can constitute a shock hazard. Transformerless audio equipment can have line AC on the chassis, the control shafts, the input, and speaker leads. Transformer equipment can also have leakage to ground or defective bypass capacitors. The following precautions are recommended when testing equipment.

Before applying AC power to the bench make sure that:

1. All equipment is securely grounded to the bench top through the ground braid leads.
2. The bench ground is secure. Use No. 12 or larger wire for bench ground lead. Some water pipes ARE NOT ground. Test should be performed to insure a good ground.
3. The bench power should be well fused. A 5 amp plugstrip fuse should be used. The use of a Ground Fault Interrupter (GFI) is also recommended on the plugstrip circuit such as the 3M Model 2701.
4. When testing transformerless equipment, an isolation transformer should be used on the AC supply circuit. After applying AC power, exercise caution while adjusting amplifier and test equipment controls since hazardous potentials will **always** be present when making tests.

Load Matching

The degree to which amplifiers and preamplifier inputs and outputs are matched or loaded will affect the accuracy of the overall test.

Power amplifiers must be loaded to their characteristic impedance, within plus or minus 1% (usually 8 ohms). The resistor load should have no more than 2% reactive components. This restriction often precludes the use of some types of wirewound resistors. An accurate non-reactive, high power load can be constructed for the power level (wattage) and impedance required by connecting a number of one or two-watt carbon resistors in parallel. A photo of a homemade load constructed with 1 watt carbon resistors immersed in oil to dissipate extra power is shown in Figure 6.

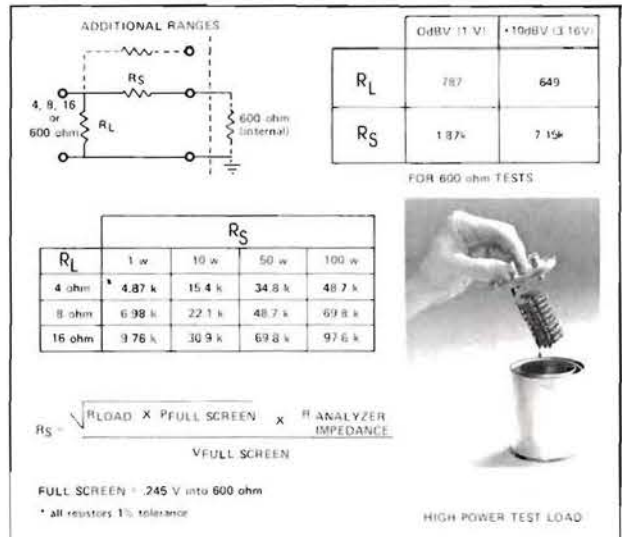

Figure 6 Load Matching Chart

The amplifier output must be matched to the 600 ohm spectrum analyzer input. A chart of values for 600 ohm amplifier matching pads as well as for other common values is also shown in Figure 6.

Preamplifiers should see a 100 kilohm slightly capacitive load such as the device in Figure 7 would provide.

Sometimes a test probe is the best way to test or troubleshoot a circuit. To maintain frequency response and minimal loading, use a 10X probe connected directly through the input of the analyzer. Select HI Z input. To measure higher voltages, construct a pad as illustrated in Figure 8.

The input signal supplied by a signal generator should be applied in series with an impedance equal to the source impedance for which the equipment was designed. With auxiliary inputs, it is considered standard to apply the signal in series with a resistance of 5000 ohms plus or minus 5%. Undriven channels should have their inputs terminated as described above.

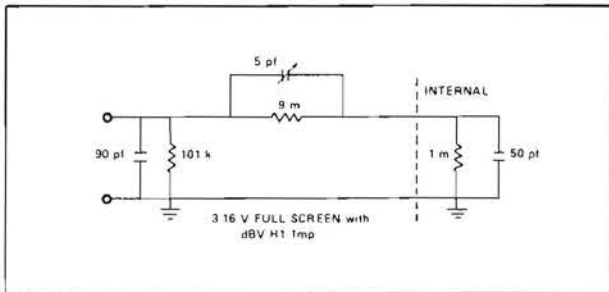

Figure 7 Preamp Load Pad

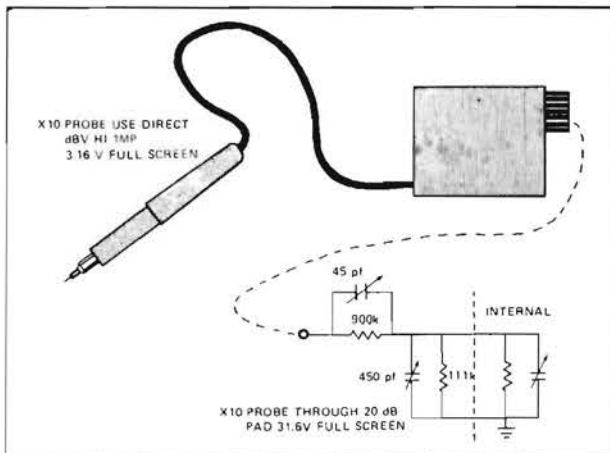

Figure 8 Using a probe with the analyzer

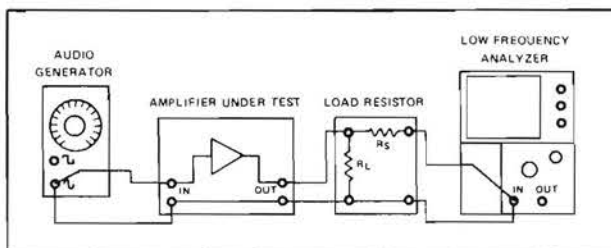

Figure 9 Equipment Setup for Measuring Power

TESTS

Power Output

Power Output of an amplifier can be roughly defined as the maximum power an amplifier can deliver per channel before distortion begins to impair the audio (music, etc.). Unfortunately, there is wide disparity in how much distortion different people will accept. Therefore, the most meaningful power output figures are obtained when the output is plotted against the amount of harmonic and intermodulation distortion.

Power measurements can be performed in many ways. A common procedure is to measure the continuous RMS output power of an amplifier for at least 30 seconds (to account for changes due to heat, power supply sag, etc.). Power measurement of stereo amplifiers is then made for each channel with both channels driven.

The Federal Trade Commission (FTC)¹ in November of 1974 enacted a regulation on measuring amplifier power output specifications.

Under this regulation, the amplifiers must be preconditioned by simultaneously operating all channels at one third of rated power for one hour using a 1000 Hz tone. Complete descriptions of these new rules are available through the FTC.

Other power tests exist, such as the IHF² and Music Power tests. These claim to give a better picture of an amplifier's ability to respond to sudden or instantaneous demands; however, the specifics will not be covered in this procedure.

Power Output Test Procedures

1. Select a load-matching resistor combination for the amplifier being tested from the chart in Figure 6. If the maximum power output is unknown, select a load-matching combination high enough to handle any anticipated power.
2. Connect the equipment as shown in Figure 9. Set all amplifier controls to their flat positions and set the volume control to maximum.
3. Select 1 kHz on the SG502 oscillator and carefully increase the output level until the tone is visible on the analyzer screen in the 10 dB/DIV mode.
4. Watch the 2nd (2 kHz) and 3rd (3 kHz) harmonics of the 1 kHz tone. Increase the output level until the amplitude of the 2nd or 3rd harmonic increases faster than the 1 kHz tone. The level at which the harmonics (distortion) begin to increase radically (faster than the tone reference) is generally considered to be the MAXIMUM UNDISTORTED POWER OUTPUT (Figure 10).

1. "F.T.C. Standard," as published in Stereo Review, Page 81, November 1974.
2. Institute of High Fidelity Standard Methods of Measurements for Audio Amplifiers, IHF-A-201 (1966).

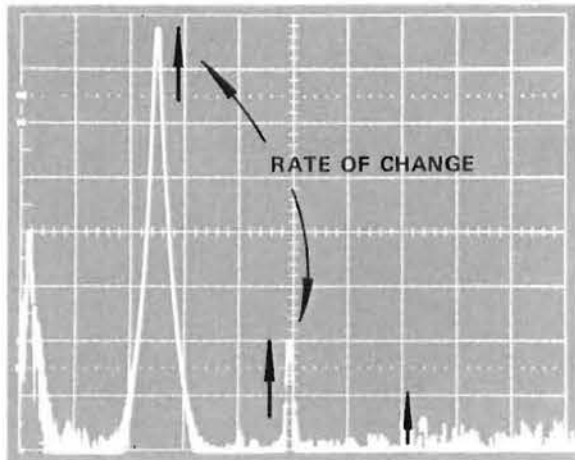

Figure 10 Distortion Crossover Point for Measuring Power

5. For the new FTC test,^{3,4} all channels of a multi-channel (stereo) amplifier should be driven to the maximum power point before power is measured.

6. Power is determined by assuming the full screen display to be the value of the load-matching combination. Switch to the 2 dB/DIV mode and note the number of dB down from the top graticule line, as shown in Figure 11. This is the power output in dB below the full screen display and can be converted directly to watts.

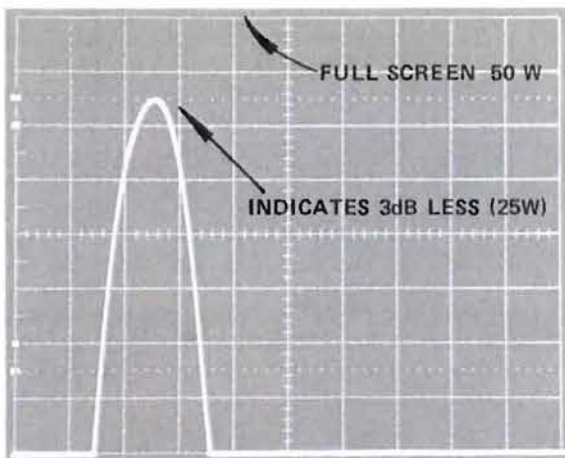

Figure 11 Calculating Power Output

Notes:

1. An alternative procedure for demonstrating maximum undistorted power is to simultaneously apply the 1 kHz tone through a plug-in vertical amplifier in the compartment next to the 5L4N and display the time domain sine wave on the scope. Increase the tone level until the sine wave visibly clips, as shown in Figure 12. The power level in dBV or dBm is then read on the spectrum analyzer display.

2. To satisfy the FTC¹ requirements, the rated power must be obtainable at all frequencies within the rated power band (width) without exceeding the total rated maximum harmonic distortion. Procedures on Power Bandwidth and

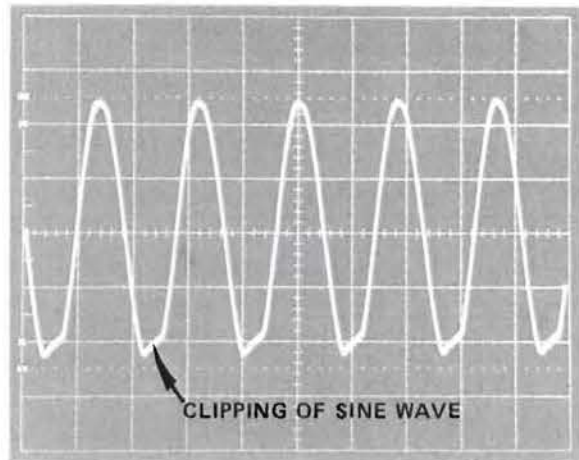

Figure 12 Visible Clipping of sine wave

Harmonic Distortion are contained in this application note and should be followed to satisfy the entire FTC regulation.

Frequency Response

Frequency Response is a measure of the amplifier's ability to pass a wide range of frequencies in the audio spectrum. Ideally, one would strive to achieve a flat response; that is, all frequencies would pass through an amplifier with equal amplification. A Hi-Fi amplifier may have controls to modify the response. These may include tone controls (bass and treble), rumble and hum filters (low frequency rolloff), scratch filters (high frequency rolloff), and a variety of tailoring devices such as the RIAA, FM de-emphasis, and tape head equalization filters. The frequency response test should provide response information of the amplifier in the flat position and should also represent the limits and interaction of the tone controls and filters.

Response of a modern Hi-Fi system is generally measured from below 20 Hz to well beyond the 15 kHz audible limit. It is measured in dB of deviation across the audio spectrum.

The 5L4N Low Frequency Analyzer is ideally suited to frequency response testing since it has a self contained tracking generator and a log sweep 20 Hz to 20 kHz mode. An amplifier can be swept under a variety of different conditions in a matter of seconds, eliminating the need for tedious measurements and point to point plots. Multiple traces of conditions can be built up either on film or on a storage oscilloscope to obtain one picture of the complete response performance of an audio device.

The rated frequency response³ is the frequency range over which the amplitude response does not vary more than plus or minus 3dB from the amplitude at 1000 Hz.

3. EIA Standard Methods of Measurement for Audio Amplifiers Used in Home Equipment, RS-234-C (1971).

4. Larry Klein, "Amplifier Power-Output Ratings: A New FTC Trade Regulation Rule," Stereo Review, Vol. 35 No. 5, Page 79, November 1974.

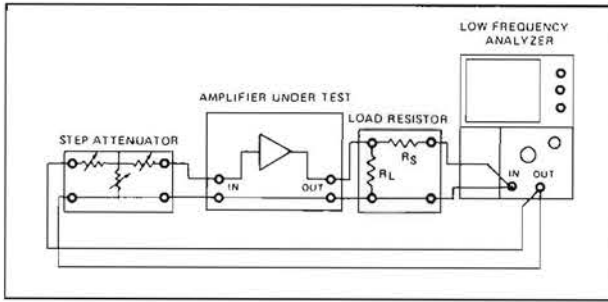

Figure 13 Frequency Response Equipment Setup

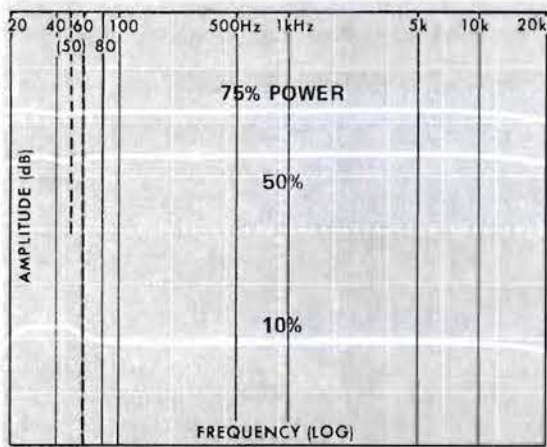

Figure 14 Frequency Response at 10%, 50% and 75% Power

Frequency Test Response Procedures

1. Select a load resistor matching pad combination for the rated power of the amplifier being tested. Connect the equipment as illustrated in Figure 13.
2. All tone controls and filters on the amplifier should be initially set for flat response. The volume (and/or loudness) controls should be set to maximum.
3. Use the LOG span on the 5L4N. An internal circuit jumper in the 5L4N provides either 20 Hz to 20 kHz, or a 100 Hz to 100 kHz LOG span. Select the 20 Hz to 20 kHz LOG span. Consult the instrument manual for details. Set the SPAN/DIV to LOG and the display mode to 10 dB/DIV (20 Hz corresponds to the left edge of the graticule). Install the Audio Graticule contained in this application note.
4. Begin the test with all the attenuation IN on the attenuator.
5. With the analyzer sweeping, reduce the attenuation of the attenuator until the rated power of the amplifier is achieved (as indicated on the display, taking the load-matching combination into account). The response, from 20 Hz to 20 kHz, should now be displayed.
6. Different power levels should also be checked such as 10% (-10 dB), 50% (-3 dB), and 75% (-1.25 dB) to see if variations occur in the response (Figure 14).

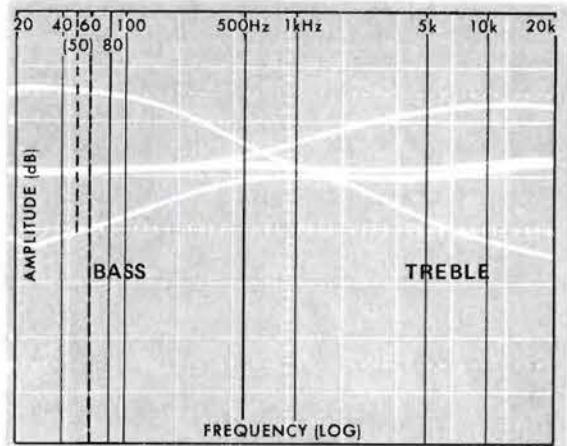

Figure 15 Tone Control Ranges

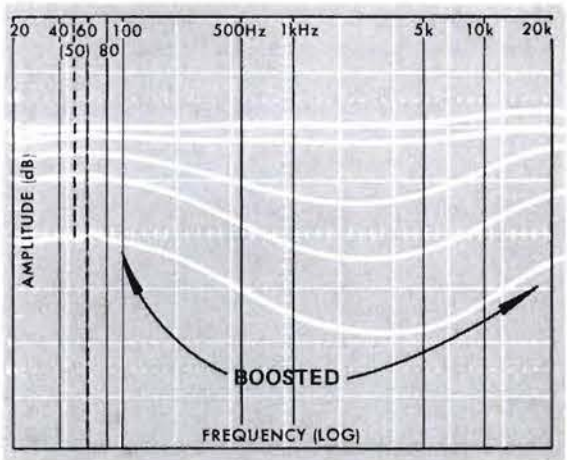

Figure 16 Loudness Control Effects

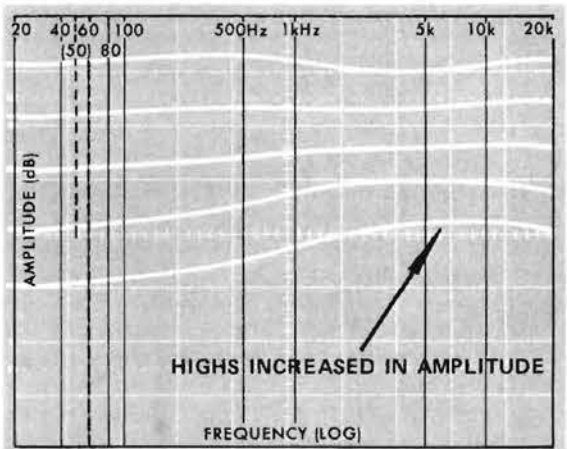

Figure 17 Response Action of Dolby "B" Encoder

7. The 2 dB/DIV display mode provides higher resolution of the response flatness.

8. The range and effect of the tone control and filters can be checked by varying these controls. If the 5L4N mainframe has storage or a camera is available, sequential displays of responses can be "built up" as shown in Figure 15.

Notes:

1. The effects produced by varying the loudness contour control can be observed (Figure 16) by sweeping the flat response each time the loudness control is increased by 1/8 turn.

2. The action of a Dolby B system encoder or decoder can be checked or noted by sweeping the device each time as the input level is reduced by 10 dB steps (Figure 17).

3. EIA standards³ recommend that the frequency response be measured at a power output not higher than 10dB below the rated power output and not lower than 20dB above residual hum and noise.

Harmonic Distortion

Harmonic Distortion or THD (total harmonic distortion) is determined by measuring and summing the amplitude level of the various harmonics that occur when a single, pure tone is passed through an amplifier. This is the most common distortion test performed on amplifiers. Harmonics can be predicted to occur in sequence (2nd, 3rd, 4th, etc.). Therefore, a 1000 Hz tone would have a 2nd harmonic of 2000 Hz, a 3rd harmonic of 3000 Hz, etc. The harmonics represent various amounts of distortion as shown in Figure 18.⁵

The low frequency analyzer permits evaluation of the components contributing to THD and also makes it possible to visually and graphically reference output level (power) to distortion. The 5L4N in combination with the SG502 audio oscillator can make 70 dB THD (.034%) measurements. With auxiliary fixed filters, this range can be extended to measure 100 dB (.001%) THD. Complete details are contained in the notes that follow.

Harmonic distortion is generally plotted against frequency at different power levels across the audio spectrum. The following procedure describes one method of measuring harmonic distortion.

Procedures

1. This test is usually conducted when the power output of an amplifier is measured. The equipment setup is shown in Figure 9. Set the amplifier controls for a flat response and maximum volume.

2. Select a 1000 Hz¹ tone from the audio generator (SG502). Increase the output level until the reference power rating of the amplifier is reached, as indicated by the 2 dB/DIV display on the spectrum analyzer screen.

3. Harmonic distortion appears as multiple signals above the fundamental 1000 Hz tone. Switch to 10 dB/DIV mode and observe the position and amplitude of the 2nd harmonic (2000 Hz) relative to the 1000 Hz reference tone (Figure 19). The amplitude ratio between the two, in dB, is the second order harmonic distortion. This ratio can be converted to percentage of distortion by referring to the chart in Figure 20.

4. Similarly, the amplitude ratio between the reference and higher order components may be calculated and converted to percentage of distortion.

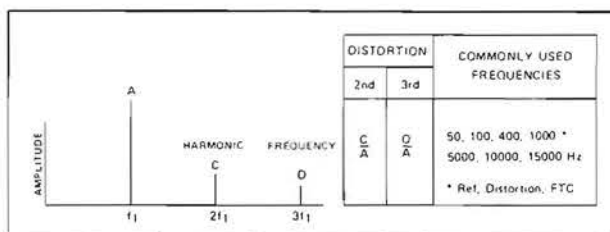

Figure 18 Harmonic distortion method of measurement

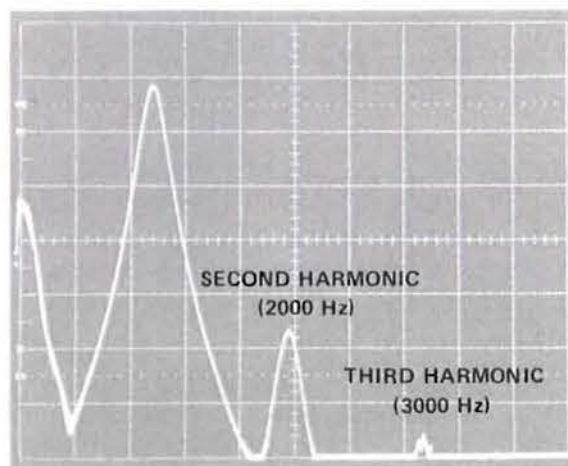

Figure 19 Harmonic Distortion with Strong Second Order Components

RATIO in dB	% of READING	RATIO in dB	% of READING
20, (40:60)	10% (.1% .1%)	30 (50:70)	3.16% (.31, .031%)
21	8.9	31	2.87
22	7.94	32	2.51
23	7.08	33	2.24
24	6.31	34	2.00
25	5.62	35	1.78
26	5.01	36	1.59
27	4.47	37	1.41
28	3.98	38	1.26
29	3.55	39	1.12

Figure 20 Chart for Conversion from dB's to Percentage Readings

5. James S. Aagaard, "An Improved Method for the Measurement of Nonlinear Audio Distortion," IRE Transactions on Audio, Page 121, 1958.

5. THD (Total Harmonic Distortion)⁶ is calculated by comparing the reference tone level to the RMS sum of all harmonic levels. The sum of the harmonics can be determined by using the chart in Figure 21. If all other harmonics are 6 dB or more down from the 2nd harmonic, one can disregard the higher order harmonics and use only the second to obtain an accurate THD figure (see Figure 22).

6. The harmonic distortion can be plotted against frequency at various power levels such as 10%, 50% and 100% on a suitable chart. This will produce results similar to those illustrated by Figure 23.

Note:

1. THD figures closer to actual operation can be obtained by setting the volume control at less than maximum, then increasing the output level of the audio generator to bring the power output of the amplifier up to the rated reference.

dB DIFFERENCE	ADD TO HIGHER LEVEL
Same (0dB)	3.01
1 dB	2.54
2	2.13
3	1.76
4	1.46
5	1.19
6	.97
7	.79
8	.64
9	.51

Figure 21 Correction Factors for Addition of Components

2. The 70 dB (.031%) range of measurement that is possible with the 5L4N Low Frequency Spectrum Analyzer can be extended to 100 dB or more (.001%) by adding a band stop filter tuned to suppress the fundamental test tones between the amplifier and 5L4N INPUT. The oscillator must also be clean to 100 dB and may require extra bandpass filtering. Complete details for extended range measurements are shown in Figure 24.

3. In some situations, it may be difficult to distinguish between the harmonics and the noise floor. The noise floor may be moved down by selecting a slower sweep speed which will, in turn, automatically select a narrower RESOLUTION B.W.

4. EIA standards discuss a parameter called Low Power Distortion. It is the highest value of total harmonic distortion (THD) measured on a 1kHz tone from 6dB to 26dB below the rated power output.

6. W.J. Warren and W.R. Hewlett, "An Analysis of the Intermodulation Method of Distortion Measurement," Proc. IRE, Vol. 36, Page 457, February 1948.

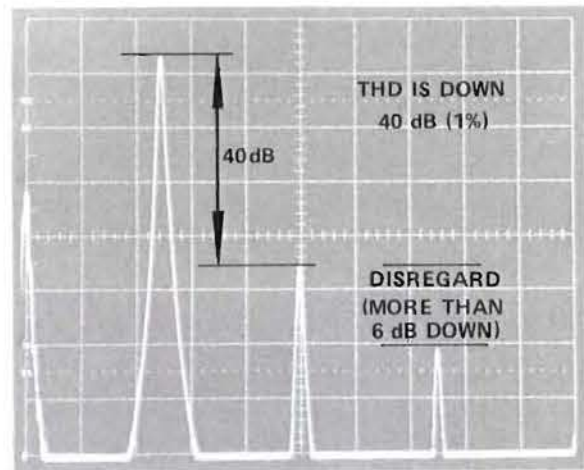

Figure 22 Calculating Percentage of Total Harmonic Distortion

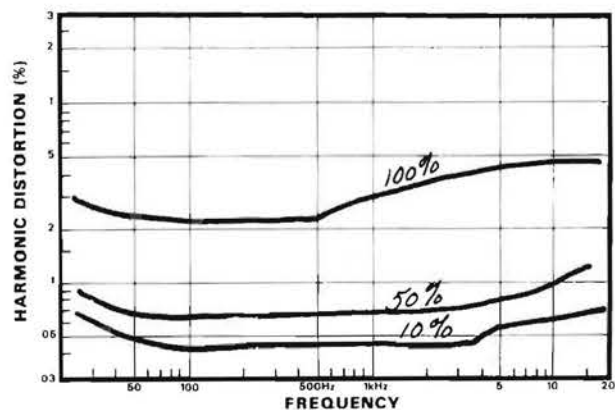

Figure 23 Harmonic Distortion Plotted vs Frequency at Different Power Levels

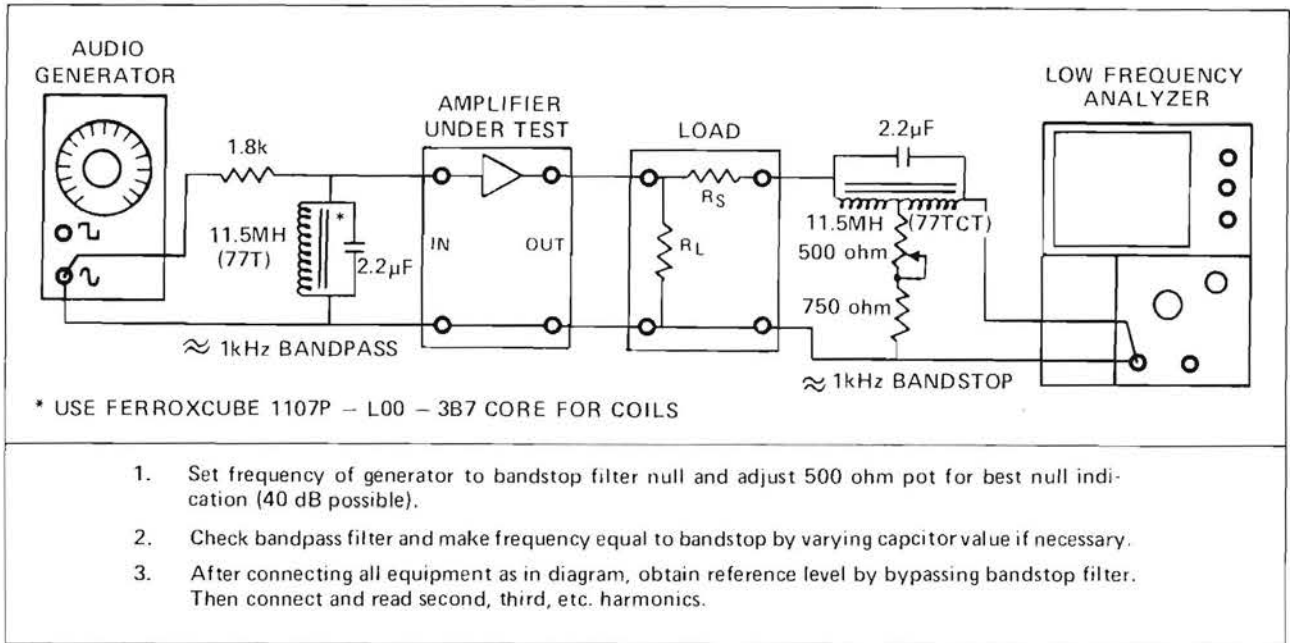

Figure 24 Extending the Range of THD Measurements at 1 kHz

Intermodulation Distortion

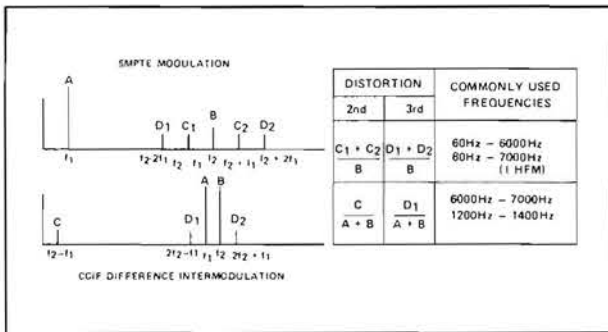

Figure 25 IM Methods of Measurement

Intermodulation Distortion is determined by putting two or more pure tones into an amplifier and measuring the amount one tone is transferred (cross modulated) onto the other.

Two commonly used intermodulation tests are described by the chart in Figure 25.

Measurement of Intermodulation Distortion⁷ has always generated a lot of controversy. All involved agree that the various measurements produce numbers that relate to performance of audio equipment; however, everyone has his/her own idea about what frequencies to use, how many, the levels, etc.

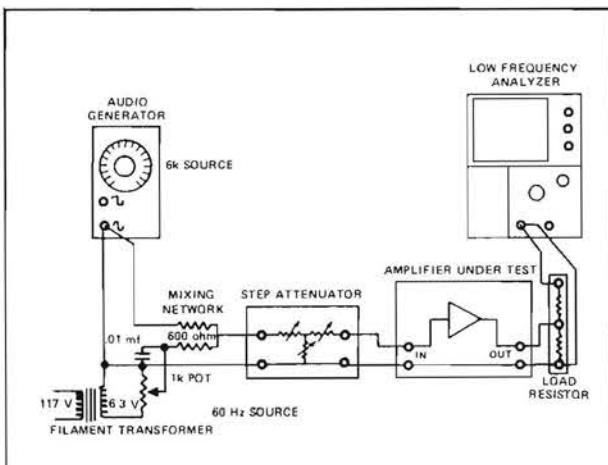

Figure 26 Equipment Setup for Intermodulation Measurement

Fortunately, the low frequency analyzer can handle all of the different known methods. The procedure presented below uses the Society of Motion Picture and Television Engineers (SMPTE) modulation method using two tones. The specific tones and ratios are recommended by the Institute of High Fidelity Manufacturers (IHFM).

Intermodulation Distortion Test Procedures

1. This test is usually conducted in conjunction with the power output measurement of an amplifier. Two tones must be used and carefully combined for Intermodulation Distortion measurement. The SMPTE method uses the filament transformer arrangement as shown in Figure 26 for the 60 Hz source, instead of a second audio generator.

7. Gerald Stanley and David McLaughlin, "Intermodulation Distortion: . . . Audio, Page 36, February 1972.

2. For the SMPTE Modulation method, select 60 Hz and 6000 Hz (7000 Hz for IHFM) in a voltage ratio of 4:1. This means that the 6000 Hz tone will be down 12 dB from the 60 Hz tone. This two tone generator setup can be checked directly with a low frequency analyzer (Figure 27).

3. Set the amplifier controls for a flat response, with the volume control set to maximum.

4. Drive the amplifier using the two tone generator to indicate 14 dB less than the rated power using the 6000 Hz tone as a reference point. The sum of the two tones will be equivalent to the rated power since the 60 Hz tone is 12 dB higher and the component of the 6000 Hz tone adds approximately 2 dB.

5. Select 10 dB/DIV display mode and a SPAN/DIV of 100 Hz. Tune the 6000 Hz signal to center screen with the FREQUENCY control.

6. Figure 28 is a typical display. The sidebands that appear around the base of the 6000 Hz tone are modulation components of 60 and 120 Hz, generated by the 60 Hz tone. Use the chart in Figure 21 to calculate the sum of the 60 Hz, 120 Hz, and other visible modulation components that appear on one side of the carrier only. Do not add the upper and lower 60 Hz or 120 Hz components together. Percentage of intermodulation distortion can be calculated from the chart in Figure 20.

Notes:

1. The CCIF Difference method of measuring requires a similar setup that uses two equal amplitude input signals from the signal generators. A typical display is shown in Figure 29.

2. Other intermodulation measurement methods, such as the Modified CCIF (symmetrical distortion), SMPE Three-Component, Noise and Notch, Impulse, and Multitone, can all be handled similarly.

3. The amount of IM distortion may decrease or change when the volume control setting is other than maximum, with the power output being maintained by increasing the signal generator output level.

4. A parameter called Low Power Intermodulation Distortion is discussed in the EIA standards. This is the highest IM distortion measured from power outputs from 6dB to 26dB below the rated power output.

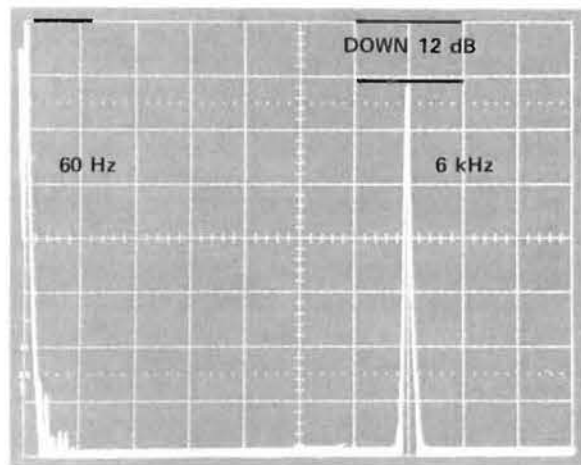

Figure 27 SMPTE Modulation Method Generator Output

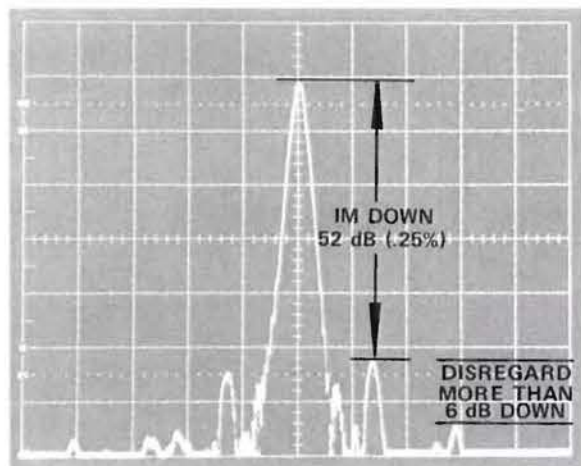

Figure 28 SMPTE Modulation Method of Measurement

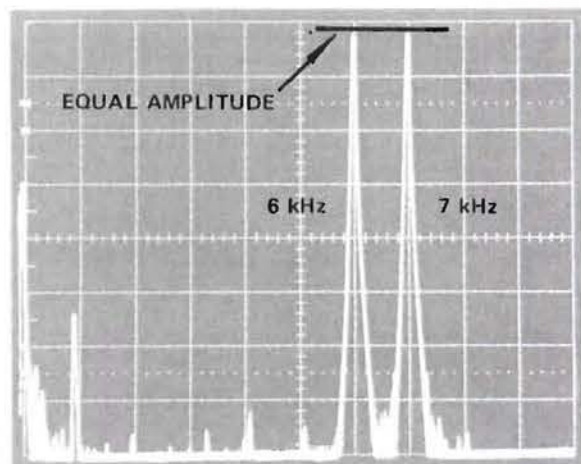

Figure 29 CCIF Difference Method of Measurement

Distortion vs Output

Distortion vs Output is a measure of the distortion for every power level of an audio amplifier system. By plotting the output power or voltage against the percentages of both harmonic (THD) and intermodulation (IM) distortion, one can readily determine the power capability for any distortion level.

A Federal Trade Commission rule requires complete disclosure of harmonic distortion (THD) using a 1000 Hz tone for all power output levels from 250 mW to rated power. This procedure has been followed for the THD measurement. IM specifications are not required to satisfy the FTC but are included in the following procedure.

Distortion/Output Test Procedures

1. Use the equipment setup and the procedure for harmonic distortion measurements and make a series of readings by using a 1000 Hz tone with a power output of 250 mW* increasing the output until the rated power of the amplifier is **exceeded**. Plot this data on a graph similar to that shown in Figure 30.

2. Use the equipment setup and the procedure for the intermodulation distortion measurements and make a series of readings that start with a power output of 250 mW increasing the output until the rated power of the amplifier is **exceeded**. Plot this data on the graph that was used to plot harmonic distortion.

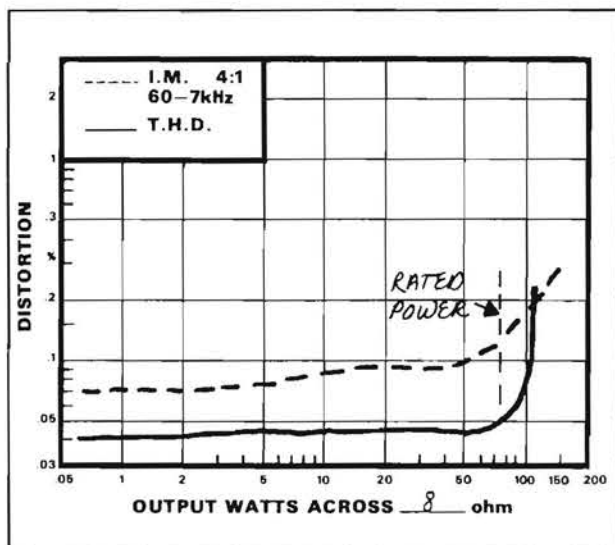

Figure 30 IM and THD Distortion of an Amplifier

Power Bandwidth

Power Bandwidth, for high fidelity test purposes⁸ is defined as the frequency range between the two points where the distortion at a power output 3 dB below the reference power intersects the reference distortion line at full power. The reference distortion at full power is usually measured using a 1 kHz tone. Then the power output is held to 3 dB less than full power while the harmonic distortion THD is plotted for tones from 10 Hz to the upper frequency limits of the amplifier.

This test is performed using the same procedure as for THD except that the distortion curve is plotted at 3 dB less than rated power, and the frequency range of the measurement is much wider.

Power Bandwidth Test Procedures

1. Use the equipment setup shown in Figure 9. Use the procedures discussed under Harmonic Distortion for reference.

2. Measure the distortion of a 1 kHz tone at the rated power output of the amplifier. This is the REFERENCE DISTORTION and should be plotted on the chart as shown in Figure 31.

3. Reduce the power output by 3 dB (to 50%) and carefully begin plotting the distortion for frequencies of 20 Hz, 40 Hz, 60 Hz, 100 Hz, etc.

4. It is important to reset the 50% power reference as indicated on the low frequency analyzer, since the frequency response of the amplifier will vary.

5. Continue to measure at regular frequency intervals until the percentage of distortion becomes at least twice as high as the REFERENCE DISTORTION.

6. The frequency between the two crossover points is the Power Bandwidth of the amplifier.

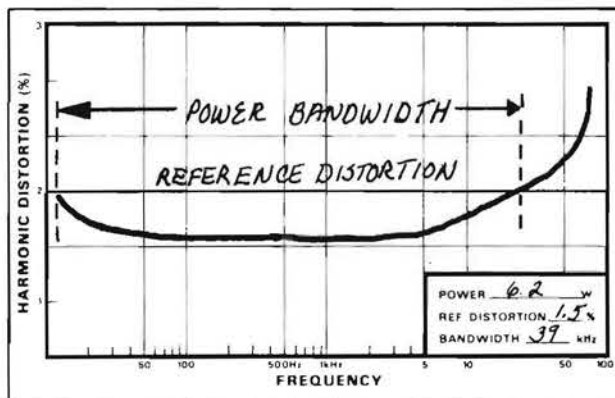

Figure 31 Power Bandwidth of an Amplifier

* Recommended reference tone by FTC, November 1974.

8. Edward C. Palmer, "8 Ways to Test Hi-Fi Amplifiers," Radio-Electronics, Vol. 44 No. 7, Page 37, July 1973.

Damping Factor

Damping Factor⁸ is a measure of output impedance versus frequency relative to a constant load R. It is an indirect measure of an amplifier's ability to remain stable while encountering speaker impedance changes (at different frequencies).

A simple way to measure damping factor is to measure the ratio at maximum power of the loaded output voltage to the unloaded output voltage. Care must be exercised during this measurement because some amplifiers cannot be driven to maximum power with a no load condition for more than a few seconds without damage.

Procedures

1. Use the equipment setup that is illustrated in Figure 32. Use a specially constructed or modified load-matching combination as shown. The load portion of the pad must be switchable.

2. Use a 2 dB/DIV display mode and apply a 1000 Hz tone. Increase the signal level to its rated output power.

For the EIA standard measurement, use a 100 Hz tone and use an output 6 dB less than the rated power output.

3. Switch to LIN mode and accurately note the voltage amplitude of the signal.

4. Disconnect the amplifier load with the switch and remeasure the signal voltage as shown in Figure 33. Duration of the no load condition should be kept short to protect the amplifier.

5. To calculate the damping factor: Damping Factor equals E_L over E_{NL} minus E_L ; where E_L is voltage with load and E_{NL} is voltage with no load.

6. If desired, the damping factor can be plotted for all frequencies from 20 Hz to 20 kHz as shown in Figure 34.

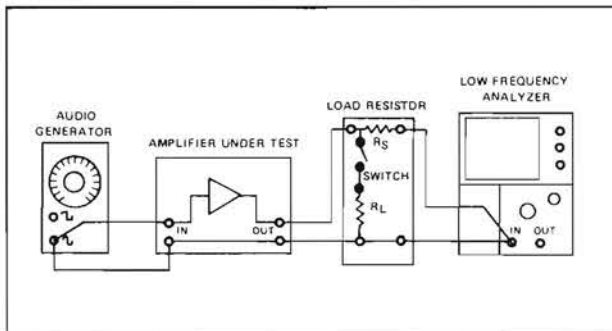

Figure 32 Damping Factor Measurements

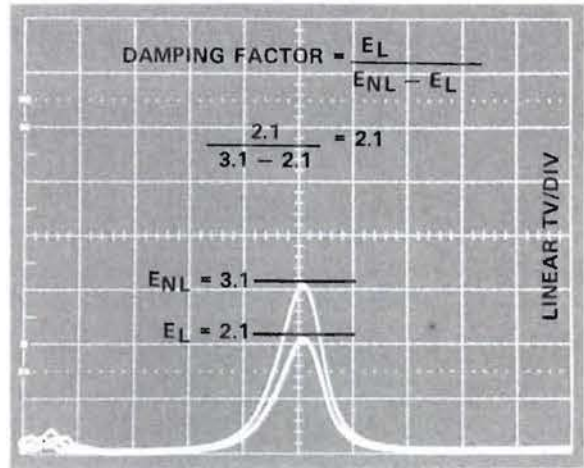

Figure 33 Damping Factor Indication

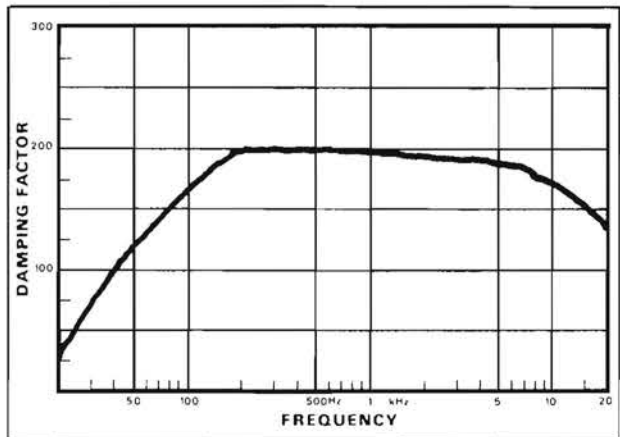

Figure 34 A Plot of Damping Factor vs Frequency

Signal to Noise Ratio

Signal to Noise Ratio⁹ is a measurement of the ratio of the rated output of an amplifier to noise (mostly thermal noise). Ideally, one would like to be able to differentiate between noise and other problems such as hum.

Signal to noise ratio measurements are performed with a variety of techniques. Some of these techniques include the use of weighting filters that take into account the response sensitivity of the human ear (the Fletcher-Munson effect), and other techniques use low pass filters to measure noise flatly across the audible range.

The Spectrum Analyzer can measure Signal to Noise Ratio easily if measurements do not specify the use of a weighting filter. In addition the analyzer permits rapid display of a noise parameter not normally attempted with traditional audio measuring sets. Spectral-Noise Density¹⁰ can be easily determined and displayed. This is a plot of noise against frequency. This permits much more accurate evaluation of systems that alter or improve noise performance such as the

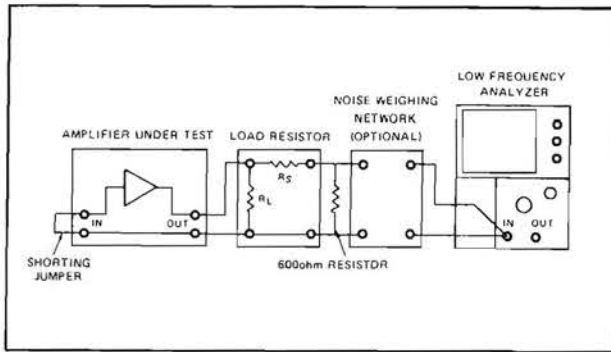

Figure 35 Equipment Connections to Measure S/N

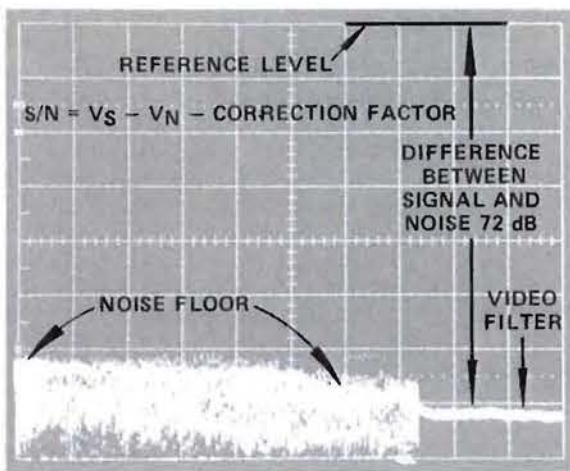

Figure 36 Measuring the Noise Floor

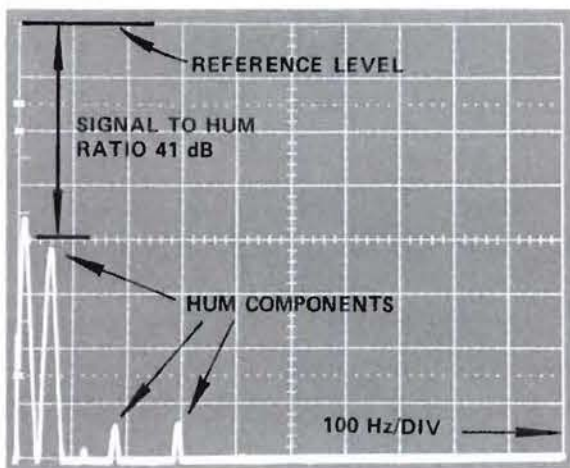

Figure 37 Example of S/N and Hum Measurements

Dolby systems, tape systems, FM receiving systems, and some modern preamplifiers.

Signal to Hum Ratio is measured while checking Spectral-Noise Density by comparing the residual 60 and 120 Hz components to the rated output of an amplifier. Hum is generally output signal components from the powerline frequency. In some modern amplifiers a high frequency power supply of 1 kHz or even supersonic (above 20 kHz) frequencies may be used. The residual signals from these frequency supplies must also be measured.

To produce a standard specification, it may be necessary to measure the weighted signal to noise ratio (WSNR)¹¹. The mathematically inclined can calculate this from the Spectral-Noise Density readings or one can use weighting filters with the tangential¹² method of measuring noise.

This technique is described briefly at the end of the Signal to Noise procedure.

Procedures

1. Set up the equipment as shown in Figure 35. Apply a 1000 Hz tone from the audio signal generator to the amplifier input. Adjust the signal level so the amplifier is driven at rated power output (volume control maximum) as indicated by the 2 dB/DIV display of the spectrum analyzer.
2. Set the RESOLUTION bandwidth to 3 kHz and select a span of 2 kHz/DIV.
3. Switch to the 10 dB/DIV display mode and note the amplitude of the 1000 Hz tone. This will be the **Signal Reference Level (VS)**.
4. Switch the 1000 Hz tone off, install a shorting jumper and observe the noise floor on the display. Use the analyzer VIDEO FILTER to average the noise so the **amplitude of the noise floor (VN)** can be measured as shown in Figure 36.
5. The difference in amplitude (Figure 37) between the signal reference level and the noise floor, less a correction from the measured bandwidth (3 kHz) to the desired bandwidth (15 kHz), is the signal to noise ratio. The correction factor to be subtracted is 7 dB. Example: S/N equals VS minus VN minus Correction Factor; S/N equals 0 dB -72 dB - (-7 dB) = -65 dB (S/N).
6. If the noise floor does not appear flat, use a narrower RESOLUTION bandwidth to determine if the noise is, in fact, uneven, or if another problem such as hum is causing an uneven display. The shape of the noise floor from 20 Hz to 20 kHz is the Spectral-Noise Density, Figure 38.

9. "Standards on Electron Devices: Methods of Measuring Noise," Proc. IRE, Vol. 41, Pages 890-896, July 1953.

10. "Standards on Sound Recording and Reproducing: Methods and Measurement of Noise," Proc. IRE, Vol. 41, Pages 508-512, April 1953.

11. RETMA Standard Amplifiers for Sound Equipment, SE-101-A, July 1947, Reprinted by EIA, May 1973.

12. Gary Franklin and Troy Hatley, "Don't Eyeball Noise," Electronic Design 24, Pages 184-187, November 22, 1973.

Notes:

1. If the noise floor is below 80 dB, the gain of the analyzer can be increased in 10 dB steps until the noise floor is visible. Every step adds 10 dB spread between the signal and noise floor.
2. Signal to hum ratio can be determined by measuring the amplitude difference between the Signal Reference Level (step 3) and any 60 or 120 Hz hum components. An example is shown in Figure 37.
3. Signal to noise and signal to hum should be rechecked through different amplifier inputs and with reduced volume control settings to determine the exact characteristics of these parameters.

I. WEIGHTED SIGNAL TO NOISE

Weighted Signal to Noise measurements can be made using an oscilloscope display to measure the RMS amplitude of the noise. Unfortunately, it is not easy to "eyeball" the amount of noise on the screen; therefore, the tangential technique was derived to permit rapid, repeatable measurements of noise.

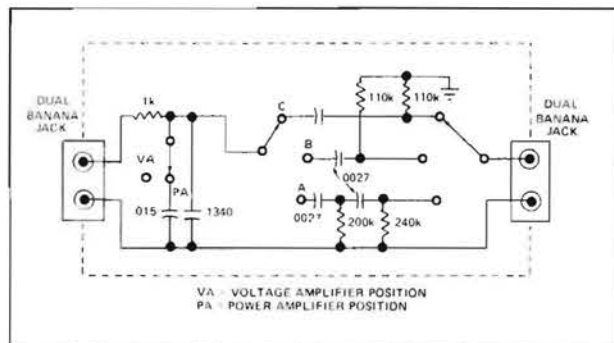

Figure 39 Weighting Network

Various weighting filters may be specified for different kinds of equipment. The schematic of one commonly used type is shown in Figure 39.

To measure noise as recommended by the EIA standard the B section of the weighting filter shown in Figure 39 should be inserted in the test setup as shown in Figure 40.

Procedures

1. Set up the equipment as shown in Figure 40. Short the amplifier input. A dual trace vertical plug-in such as the Tektronix 5A18N must be used. If this procedure is used without a weighting filter, some form of a frequency limiting filter (usually a 15 kHz low pass) MUST be used.
2. Connect the noise to both vertical channels simultaneously in the alternate-sweep mode. Two noise traces will appear (Figure 41).
3. With both channels identically calibrated, adjust the voltage offset until the dark area between the two traces just disappears (Figure 42).
4. Disconnect the inputs and measure the separation between the two traces in volts. This is VN (Figure 43).
5. The ratio between the voltage at rated power output and the noise VN is the signal to noise ratio.

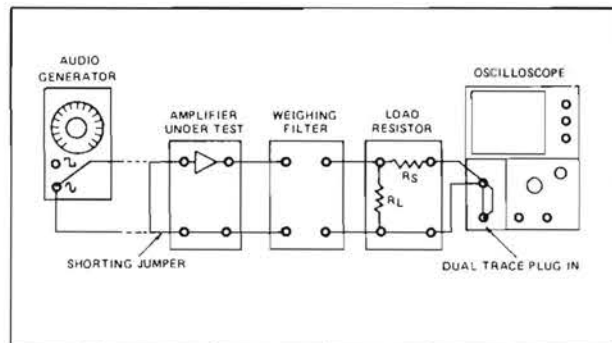

Figure 40 Equipment Setup for Weighted Signal to Noise Tests

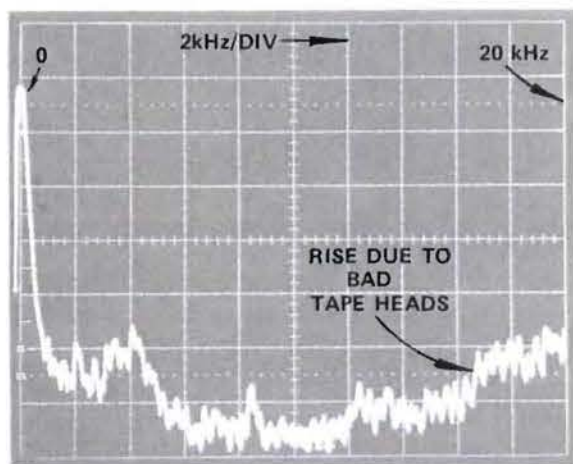

Figure 38 Spectral-Noise Density Display

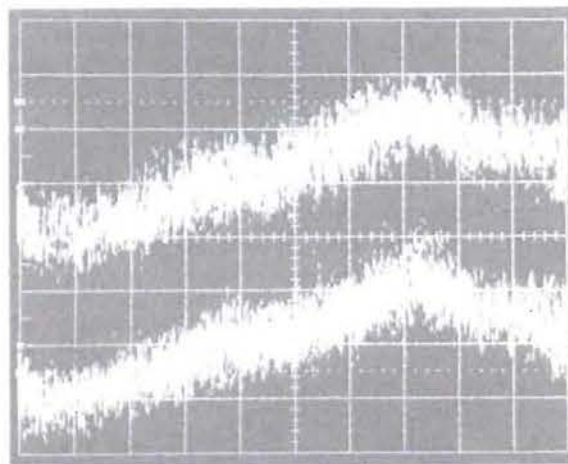

Figure 41 Dual Trace Display of Noise

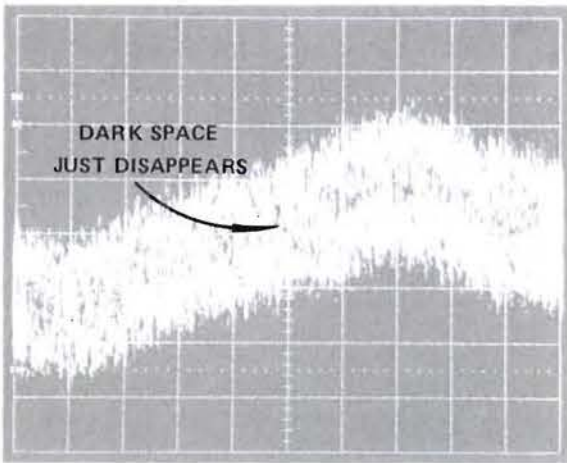

Figure 42 Offset Adjusted until Dark Area just Disappears

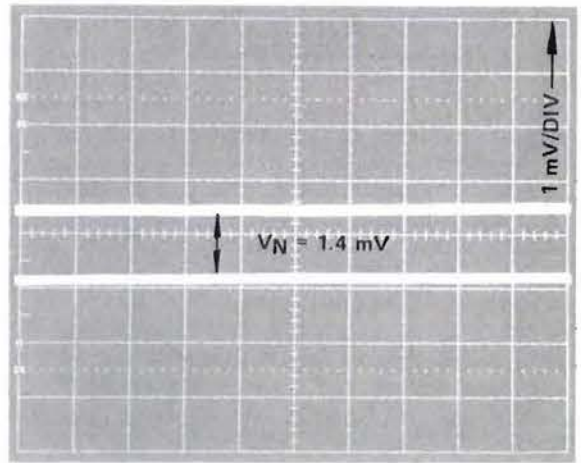

Figure 43 Measuring Separation between Two Traces

Square Wave Response

Square Wave Response is measured by passing first a 50 Hz then a 10 kHz square wave through an amplifier operating at its rated output. The resultant waveform provides a quick check of a number of parameters including frequency response, transient response, group delay, and distortion. This is strictly an oscilloscope type measurement once the rated power is determined.

Procedures

1. Set up the equipment as shown in Figure 44. The square wave output of the Audio Generator (SG502) is applied to the amplifier. The output of the amplifier is connected through the load-matching combination network and split into both the low frequency spectrum analyzer and an amplifier plug-in unit. Set the amplifier controls for a flat response and the volume control to maximum.
2. The amplifier is driven at rated power output using a 50 Hz square wave. Rated power indication on the analyzer will be 2 dB below the rated power for a single tone, because the square wave spectrum contains less fundamental frequency power than a sine wave.
3. Observe the resultant square wave response of the vertical amplifier plug-in.
4. Change the square wave generator frequency to 10 kHz and observe the vertical amplifier response (Figure 45).
5. Some information to look for is: Rounded corners indicating frequency response deficiencies; transients which indicate damping or phase problems; and axis shift of the 50 Hz square which indicates poor low frequency coupling.

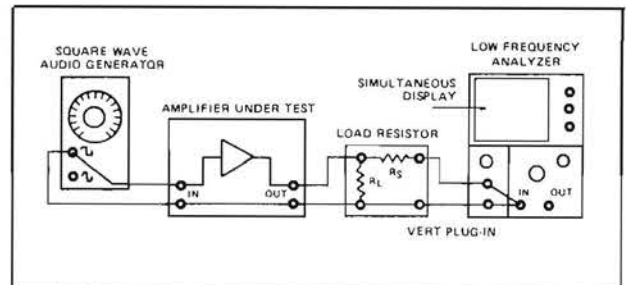

Figure 44 Equipment Setup for Square Wave Response

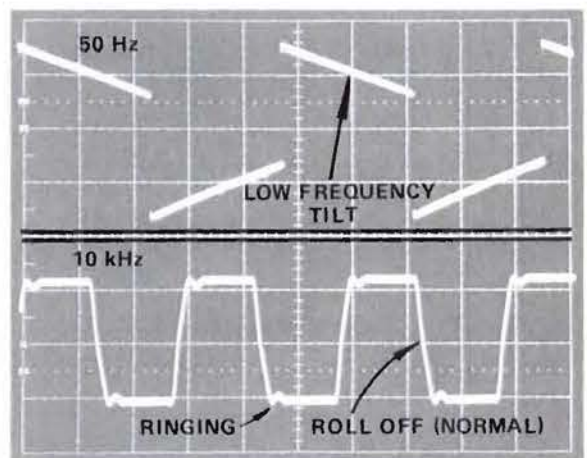

Figure 45 Display of 50 Hz and 10 kHz Square Waves

Crosstalk

Crosstalk is the amount of signal that leaks or spreads from one channel of a system into another channel or channels of the system. It is measured by driving all channels except one to rated output, then measuring the amount of signal that leaks into the idle channel. Crosstalk is usually expressed in dB's and is the ratio of the rated power output to the signal level on the idle channel.

With the Low Frequency Spectrum Analyzer, we can easily go one step further and measure the crosstalk at all frequencies from 20 Hz to 20 kHz, obtaining a display of crosstalk versus frequency in dB.

The EIA standard calls for separation (crosstalk) to be measured at 3 dB less than the Rated Power Output.

Procedures

1. Set up the equipment as shown in Figure 46. The switches may be deleted by plugging the input signal into various jacks as desired. All channel outputs must be properly terminated and unused inputs have a shielded matching resistor and not a shorting jumper connected from input to ground. Set all controls for a flat response and the volume control to maximum.
2. When testing four channel amplifiers, all the channels, except the one being measured, should be driven at rated power output.
3. Drive one channel to rated power output, using a 1000 Hz tone from the tracking generator output. Then sweep the channel using the LOG SWEEP to obtain a reference response.
4. Switch the analyzer input to the other channel and, using the LOG SWEEP MODE and log graticule, observe the crosstalk signal level in dB with respect to the reference response. The drop in dB from the rated power reference established on the other channel can be measured by using the 10 dB/DIV display mode on the spectrum analyzer (Figure 47).
5. Repeat the check on each adjoining channel.

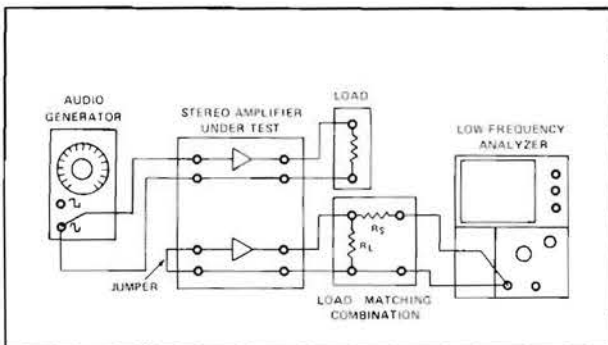

Figure 46 Setup for Measurement of Crosstalk

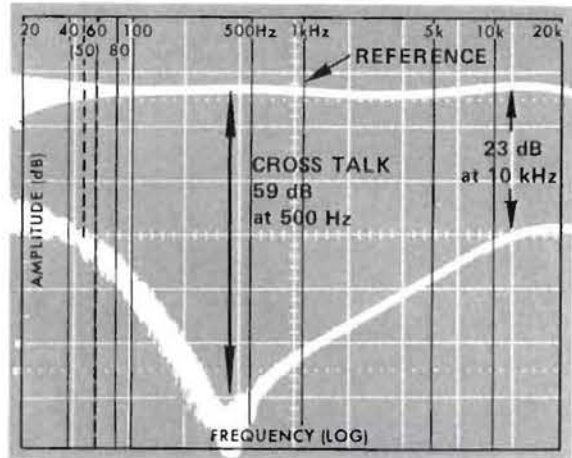

Figure 47 Crosstalk from One Channel to the Other

Sensitivity

Sensitivity checks determine how much signal (in volts) must be applied to each input terminal to drive an amplifier to its rated or some reference output. The overload point for each input is usually determined while making the sensitivity checks.

Procedures

1. Connect the equipment as shown in Figure 48. The switch is convenient though not absolutely necessary for this measurement.
2. Start with any amplifier input and use a 1000 Hz tone to drive the amplifier to its rated power output. The volume control and any input gain controls MUST be set at maximum.
3. Once rated power output is reached, switch the signal to the analyzer input. Select the LIN display mode and read the input voltage amplitude required to achieve amplifier rated power output. This voltage is the SENSITIVITY rating of the amplifier input tested.

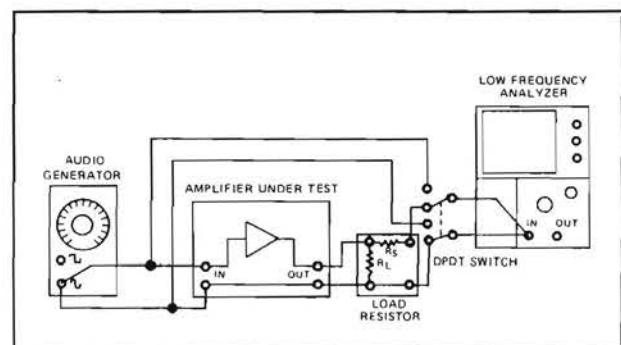

Figure 48 Sensitivity Equipment Setup

4. Using the THD procedures (part III), begin reducing the volume on the amplifier to indicate below rated output while increasing the level of the 1 kHz tone until the 2nd and 3rd harmonics increase more rapidly than the input signal. Remeasure the input voltage. This is the overload point for that input.

5. Continue this procedure for all inputs on the amplifier recording the results (Figure 49).

	SENSITIVITY FOR 10W OUTPUT		
	LEFT	RIGHT	(TYPICAL) OVERLOAD
PHONO HI	1.15 mV	1.13 mV	57 mV
PHONO LO	.38 mV	.38 mV	21 mV
AUX 1	63 mV	61 mV	3.4 V
AUX 2	62 mV	60 mV	3.4 V
TAPE MONITOR	105 mV	103 mV	8.1 V
TUNER	63 mV	61 mV	3.4 V
TAPE HEAD	.41 mV	.41 mV	20.5 mV

Figure 49 Recorded Results of Sensitivity and Overload Tests

Transient Intermodulation Distortion

Transient Intermodulation Distortion (TIM)¹³ is distortion in amplifiers that occurs principally during loud, high frequency passages. Most music contains some material that can cause TIM distortion. Amplifiers with large amounts of negative feedback are prone to TIM distortion because the amplifier loop, if improperly designed, requires too much time to respond to rapid transients.

Ever since the introduction of the transistor power amplifier, the "transistor sound" has been discussed. Even though in many cases a transistor amplifier tested better in terms of distortion than a tube counterpart, during a listening test the tube unit would unmistakably perform better. TIM distortion is one explanation of these dis-

crepancies. Transistor amplifiers test excellent using steady state harmonic and intermodulation tests. However, music material generates amplifier distortion because of its transient nature.

A popular explanation of the source of TIM is that the transient reaches or exceeds the slew rate of the amplifier causing an instant, severe intermodulation condition until the negative feedback signal catches up with and corrects the distortion.

No measurement standards exist to date.¹⁴ However, a square wave with a high frequency sine wave has been used to observe this distortion.

Presented below is a technique that used a 6 kHz sine wave mixed with a 500 Hz square wave to demonstrate TIM distortion. However, no single number results to adequately indicate the amplifier's performance.

Procedures

1. Connect the equipment as shown in Figure 50. Two SG502 Audio Generators must be combined as shown, one set to produce 500 Hz square waves, the other 6 kHz sine waves. A FG501 may be substituted for the square wave source. The square wave used should have excellent symmetry.

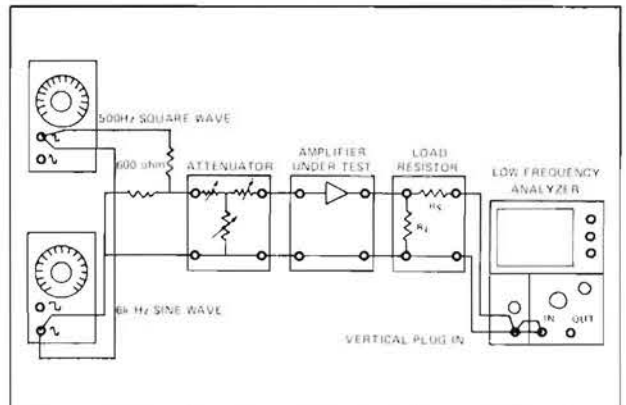

Figure 50 Equipment setup for TIM demonstration

2. Temporarily bypass the amplifier and set up the generator levels in a voltage ratio of about 5:1. Then carefully adjust the frequency of the 6 kHz generator until a stationary pattern is obtained similar to the top trace in Figure 51.

3. Reconnect the amplifier and remove attenuation until 50% of rated power is indicated by the 500 Hz fundamental on the analyzer display.

13. Matti Ojala, "Transient Distortion in Transistorized Audio Power Amplifiers," IEEE Transactions on Audio..., Vol. AU-18, No. 3, Page 234, September 1970.

4. One of the characteristics of TIM may appear on the oscilloscope display as in the lower trace of Figure 51. This display shows a temporary "swamping" of the 6 kHz tone immediately after the 500 Hz transition.

5. Bypass the amplifier again and select 1 kHz/DIV in the LINEAR sweep mode on the spectrum analyzer. Manually select a resolution bandwidth so that good sideband resolution is obtained as shown in Figure 52.

6. Observe the pattern obtained directly from the source. Note that the even harmonics of the 500 Hz signal are suppressed (Figure 52).

7. Reconnect the amplifier and note that TIM may be observed as 1 kHz sidebands of the 6 kHz signal as shown in Figure 53.

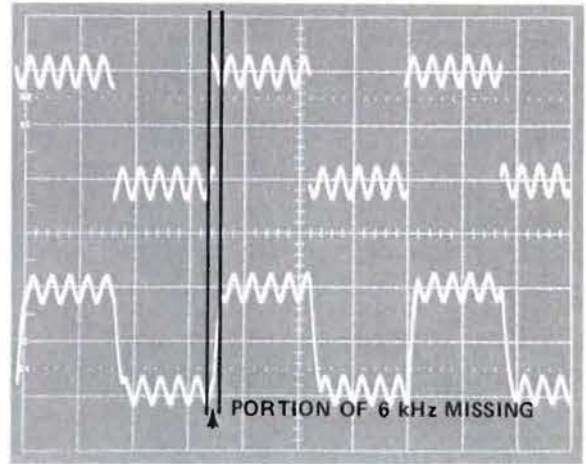

Figure 51 TIM Display in the Time Domain

14. W. Marshall Leach, "Transient IM Distortion in Power Amplifiers," Pages 34-41, Audio, February 1975.

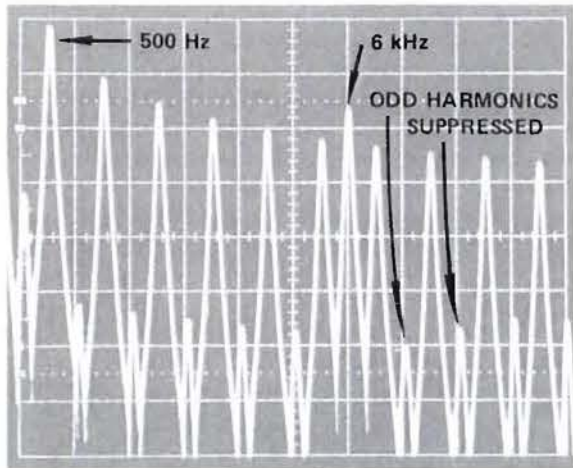

Figure 52 500 Hz 6 kHz source signal for TIM demonstration

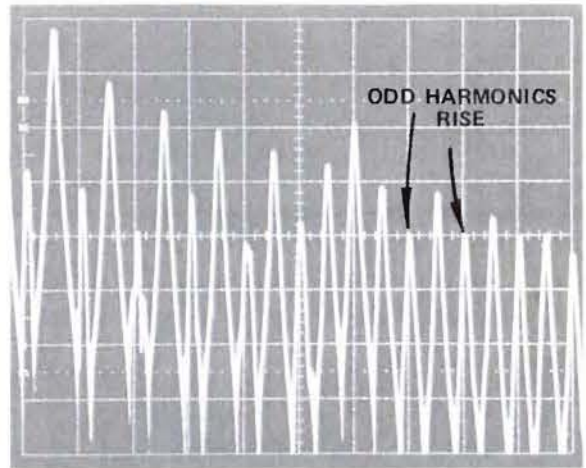

Figure 53 TIM Display in the Frequency Domain

SERVICING HINTS

The combination Low Frequency Spectrum Analyzer-Oscilloscope offers tremendous flexibility to permit rapid servicing of high quality Hi-Fi and stereo equipment. An oscilloscope probe can be connected directly to the front panel of the 5L4N making it easy to pinpoint problem areas.

While it is impossible to list all the steps and techniques one might use, the following are some of the things we came across while preparing this applications brochure.

A. BIAS VOLTAGE ADJUSTMENT

The adjustment of bias voltage on the output stage is traditionally done with a voltmeter or a distortion analyzer. The Low Frequency Analyzer can be connected to an amplifier and using a single tone (like 1 kHz) the bias can be quickly set for minimum harmonic amplitude. Then the output power can be reduced and the low level crossover distortion that sometimes occurs can be double checked.

B. INAUDIBLE FREQUENCIES

Sometimes a Hi-Fi system doesn't seem to perform correctly and the problem can be traced to overloading or distortion due to INAUDIBLE frequencies being passed by the amplifier.

The more common causes of these frequencies are inaccurate adjustment of the stereo traps (letting 19 and 38 kHz into the audio channel); tape recorder bias traps improperly adjusted; improper bypassing of inputs letting radio frequency energy into the amplifier; and sometimes an amplifier will just oscillate all by itself.

By using the 10 kHz/DIV MODE of the analyzer routinely when checking an amplifier, these kinds of problems will be immediately visible. Figure 54.

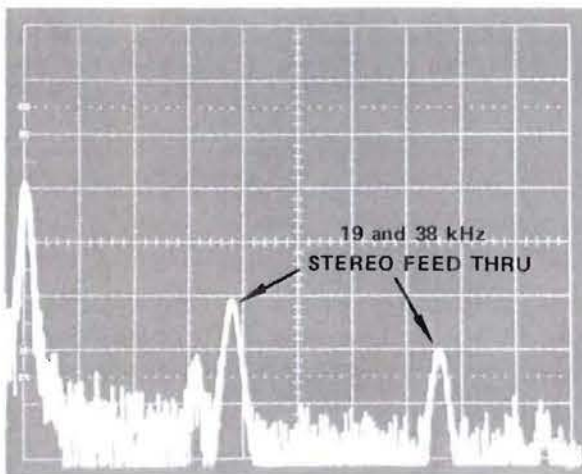

Figure 54 Misadjustment of stereo traps in Hi-Fi receiver

C. STAGE BY STAGE GAIN CHECK

Stage by Stage Gain Check are often used to find the source of a weak or distorted channel in an amplifier system. A modification of the stage by stage check can be performed with the Low Frequency Spectrum Analyzer using the tracking generator output. Insert the tracking generator into an amplifier input, and using a X10 oscilloscope probe, begin at the input stages of the amplifier and monitor the input and output of each stage.

Channels can be compared to each other or gain and response can be checked against the manufacturers' recommendations. Certain problems will be immediately obvious if they exist.

1. Gain differences will show up on the display.
2. Low frequency rolloff will indicate such things as defective stage coupling or output coupling capacitors.
3. High frequency rolloff could indicate defective emitter bypass capacitors or other associated problems.

The test can then be repeated with no signal on the amplifier input, watching the noise floor. A high noise floor rise between stages is characteristic of a defective or hot component.

Finally, using a 1 kHz tone, a stage by stage check can be performed while watching the 2nd and 3rd harmonics for signs of a stage with higher than normal distortion. Typically, the output stage should contribute most of the distortion in an amplifying system.

D. STYLUS PRESSURE ADJUSTMENTS

Phono cartridge weight adjustments are often one of the least understood areas of Hi-Fi. The manufacture attempts to recommend the lowest stylus pressure that produces minimum distortion. By using a continuous tone test record, and starting with a new stylus, the pressure is increased progressively until the lowest distortion (2nd and 3rd harmonics) of the tone are noted. This test can be easily duplicated in the shop using the low frequency analyzer.

A little imagination, and a low frequency spectrum analyzer can go a long way toward taking the mystery out of Hi-Fi repairs. Other equipment such as tape recorders, speakers, and electronic instruments (like organs) can be analyzed. Complete PA systems used in auditoriums can be swept and analyzed, or the acoustics and noise levels of an auditorium could be checked.

This pamphlet only covers one small application area for the low frequency analyzer. We hope that you will have an opportunity to experiment with our applications and expand them to fit your individual needs.

STANDARD AUDIO TEST FORM

<p>EQUIPMENT TESTED</p> <p>Manufacturer _____</p> <p>Model _____</p> <p>Serial No. _____</p>	<p>PERSON PERFORMING TESTS</p> <p>_____</p> <p>_____</p> <p>_____</p> <p>Date _____</p>
<p>POWER OUTPUT FOR _____ % OF THD</p> <p>CHNL A _____ w CHNL C _____ w</p> <p>CHNL B _____ w CHNL D _____ w</p> <p>S/N at RATED POWER _____</p> <p>DAMPING FACTOR _____</p> <p>OUTPUT IMPEDANCE _____</p>	

**INSERT
PHOTO**

**Response at 10% , 50%, and 100%
power**

**INSERT
PHOTO**

**Tone control response at 50%
power**

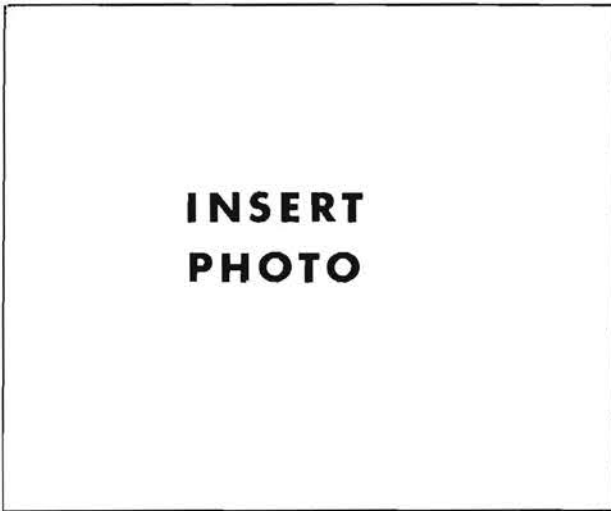

Spectral - noise density

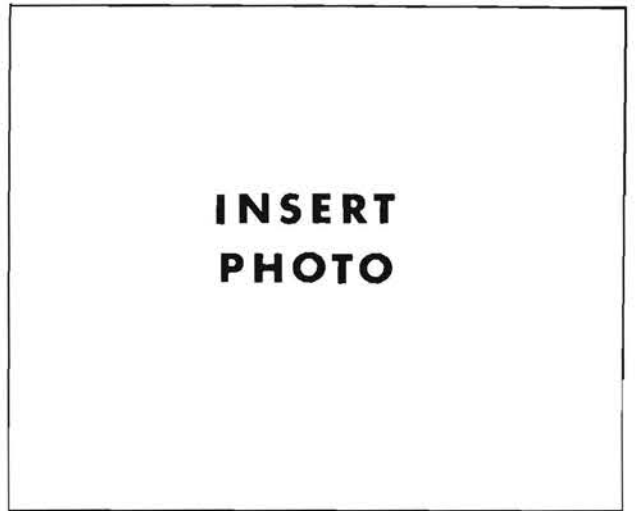

**Square wave response
50 Hz - 10 kHz**

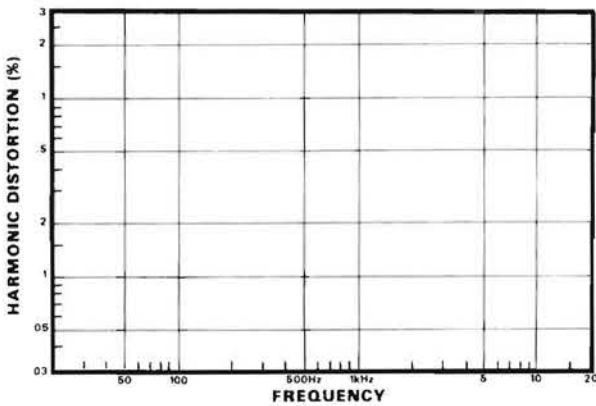

Harmonic distortion (THD)

	SENSITIVITY FOR		OUTPUT
	LEFT	RIGHT	(TYPICAL) OVERLOAD
PHONO HI			
PHONO LO			
AUX 1			
AUX 2			
TAPE MONITOR			
TUNER			
TAPE HEAD			

Sensitivity & Overload

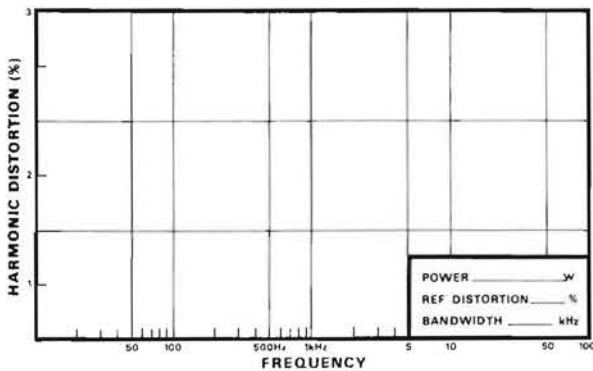

Power bandwidth

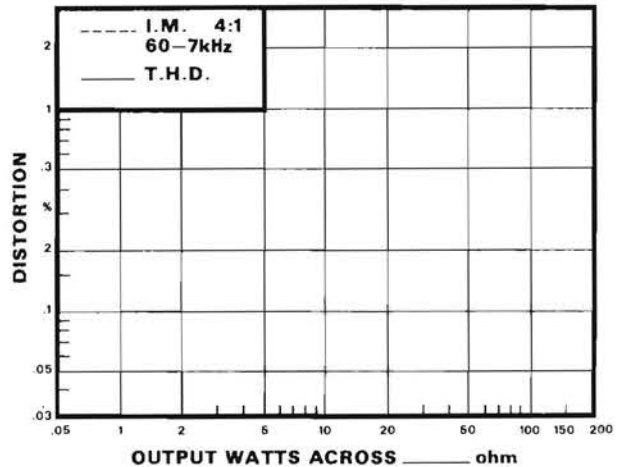

Distortion and power

**TEKTRONIX**committed to
technical excellence

Rev. 2/11/75

Tektronix, Inc.

P. O. Box 500, Beaverton, Oregon 97077

Telephone: (503) 644-0161 TWX: 910-467-8708 TEKTRONIX BEAV. Cable: TEKTRONIX

FIELD ENGINEERING OFFICES**ALABAMA**

*Huntsville 35801
Suite 8, 3322 S. Memorial Parkway
Phone (205)881-2912

ARIZONA

*Phoenix 85034
2643 E. University Drive
Suite 113
Phone (602)244-9795
Tucson Area: Enterprise 383

CALIFORNIA

*Concord 94520
2339A Stanwell Circle
Phone (415)687-8350
From Oakland, Berkeley, Richmond,
Albany and San Leandro: 254-5353
Info. Disp. Prod. (415)687-4681

*Irvine 92705
16601 Hale Ave.
Phone (714)556-8080-89
(213)778-5225, 6

*San Diego 92111
6841 Convoy Court
Phone (714)292-7330

*Santa Clara 95051
3200 Coronado Drive
Phone (408)249-5500

*Van Nuys 91406
16930 Sherman Way
Phone (213)987-2600
From L.A. call: 873-6868

COLORADO

*Denver
6801 So. Yosemite St.
Englewood 80110
Phone (303)771-8012

CONNECTICUT

Millford 06460
20 Commerce Park Road
Phone (203)877-1494

FLORIDA

*Fort Lauderdale 33311
1871 West Oakland Park Blvd.
Phone (305)731-1220
Also serves Puerto Rico and
U.S. Virgin Islands
From Miami: 947-6053

*Orlando 32803
Suite 109, 1040 Woodcock Rd.
Phone (305)894-3911
From The Cape Kennedy Area:
636-0343

Pensacola 32503
Suite 130, 4900 Bayou Blvd.
Phone (904)476-1897

*Field Office/Service Center

iService Center

GEORGIA

*Atlanta 30341
Suite 3, 2251 Perimeter Park
Phone (404)451-7241

HAWAII

Sales:
Van Nuys, CA 91406
16930 Sherman Way
Phone ENTERprise 8072
†Honolulu Service Center
EMC Corporation
2979 Ualena Street
Phone (808) 847-1138

ILLINOIS

Chicago
1541 Elmhurst Rd.
Elk Grove Village 60007
Phone (312)593-2830
Chicago Service Center
Unit E
175 Randall Rd.
Elk Grove Village 60007
Phone (312)956-1774

INDIANA

*Indianapolis 46219
6121 East 30th Street
Phone (317)546-2408

KANSAS

*Kansas City
8920 West 62 Terrace
Shawnee Mission 66202
Phone (913)262-8770

LOUISIANA

*New Orleans
3004 34th St.
Metairie 70001
Phone (504)837-8454

MARYLAND

Baltimore
1526 York Road
Lutherville 21093
Phone (301) 321-7000
From Harrisburg, Lancaster and
York Area call: ENTERprise 1-0631

*Rockville 20850
1335 Piccard Drive
Phone (301)948-7151

MASSACHUSETTS

*Boston
244 Second Avenue
Waltham 02154
Phone (617)890-4550
From Providence: (401)739-4771
(Info. Disp. Prod. (617)890-5950)

MICHIGAN

*Detroit
22132 West Nine Mile Road
Southfield 48075
Phone (313)358-3122

MINNESOTA

*St. Paul 55112
3563 N. Lexington Ave.
Phone (612)484-8571

MISSOURI

*St. Louis
422 Anglum Rd.
Hazelwood 63042
Phone (314)731-4696

NEW JERSEY

*Springfield 07081
954 South Springfield Avenue
Phone (201)379-1670

NEW MEXICO

*Albuquerque 87108
1258 Ortiz Drive, S.E.
Phone (505)268-3373
Southern N.M. Area: ENTERprise 678
Southern Nevada Area: ENTERprise 678

NEW YORK

Albany
678 Troy Road
Latham 12110
Phone (518)785-3353

*Endicott
3214 Watson Blvd
Endwell 13760
Phone (607)748-8291

*Long Island
100 Crossways Park West
Woodbury, L.I. 11797
Phone (516) 364-9060
(212) 895-9215

Poughkeepsie 12603
31 Haight Avenue
Phone (914) 454-7540

Rochester 14623
77 Ridgeland Rd.
Phone (716)244-2600

*Syracuse 15212
1 Northern Concourse
North Syracuse
Phone (315)455-6661

NORTH CAROLINA

*Raleigh 27612
Suite 104
3725 National Dr.
Phone (919)782-5624

OHIO

*Cleveland 44129
5689 Pearl Road
Phone (216)884-6558

Columbus
Suite 5, 12 West Selby Blvd.
Worthington 43085
Phone (614)888-4040

*Dayton 45449
501 Progress Rd.
Phone (513)859-3681

OKLAHOMA

Oklahoma City 73105
Suite 201
800 N.E. 63rd
Phone (405)848-3361

OREGON

Portland
8845 S.W. Center Court
Tigard 97223
Phone (503)639-7691

†Factory Service Center
Tektronix Industrial Park
Beaverton 97005
Phone (503)644-0161, Telex 36-0485

PENNSYLVANIA

Philadelphia
165 Indiana Avenue
Ft. Washington 19034
Phone (215)542-1440

†Philadelphia Service Center

1030 W. Germantown Pike
Norristown 19401
Phone (215)539-5540

*Pittsburgh
3834 Northern Pike
Monroeville 15146
Phone (412) 373-3250

TEXAS

*Dallas 75240
4455 Sigma Road
Phone (214)233-7791

*Houston 77036
5755 Bonhomme
Suite 420
Phone (713)783-1910

San Antonio 78228
Suite 100, 4415 Piedras St., West
Phone (512)736-2641, 2
From Austin Area:
ENTERprise 9915

UTAH

*Salt Lake City 84115
65 West 2950 South
Phone (801)484-8501

VIRGINIA

Hampton 23366
1929 Colliseum Dr.
Phone (804)826-4020

WASHINGTON

*Seattle 98188
641 Industry Drive
Phone (206)575-0180